



Add:50 Carrington Rd Castle Hill 2154

Tel: 1300 572 154

Web:Beyondlift.com.au

K900 TRACTION HOME LIFT

Make Your Living More Comfortable



1 Table of CONTENTS

01-10

K900 Traction Home Lift

11-14

Standard Configuration

15-19

Optional Configuration

20

Basic Information

K900 Traction Home Lift

Focus On Home Elevators

K900 Traction Home Lift

K K900 TRACTION HOME LIFT

Make your living more comfortable



Steel belt traction



Decor Can Be Customized



Multiple Security Mechanisms

Aluminum Alloy Shaft



Super Narrow Door Frame, Only 1cm.

Independent Frame Glass Design, Without Additional Construction Costs. With Good Transparency, integrate With Interior Decoration. Flexible Installation Position, lifespan Long Term. Industrial Grade Aluminum Alloy Shaft With Laminated Tempered Glass.

Decor Can Be Customized

“MAKE YOUR ELEVATOR UNIQUE AND UNIQUE”

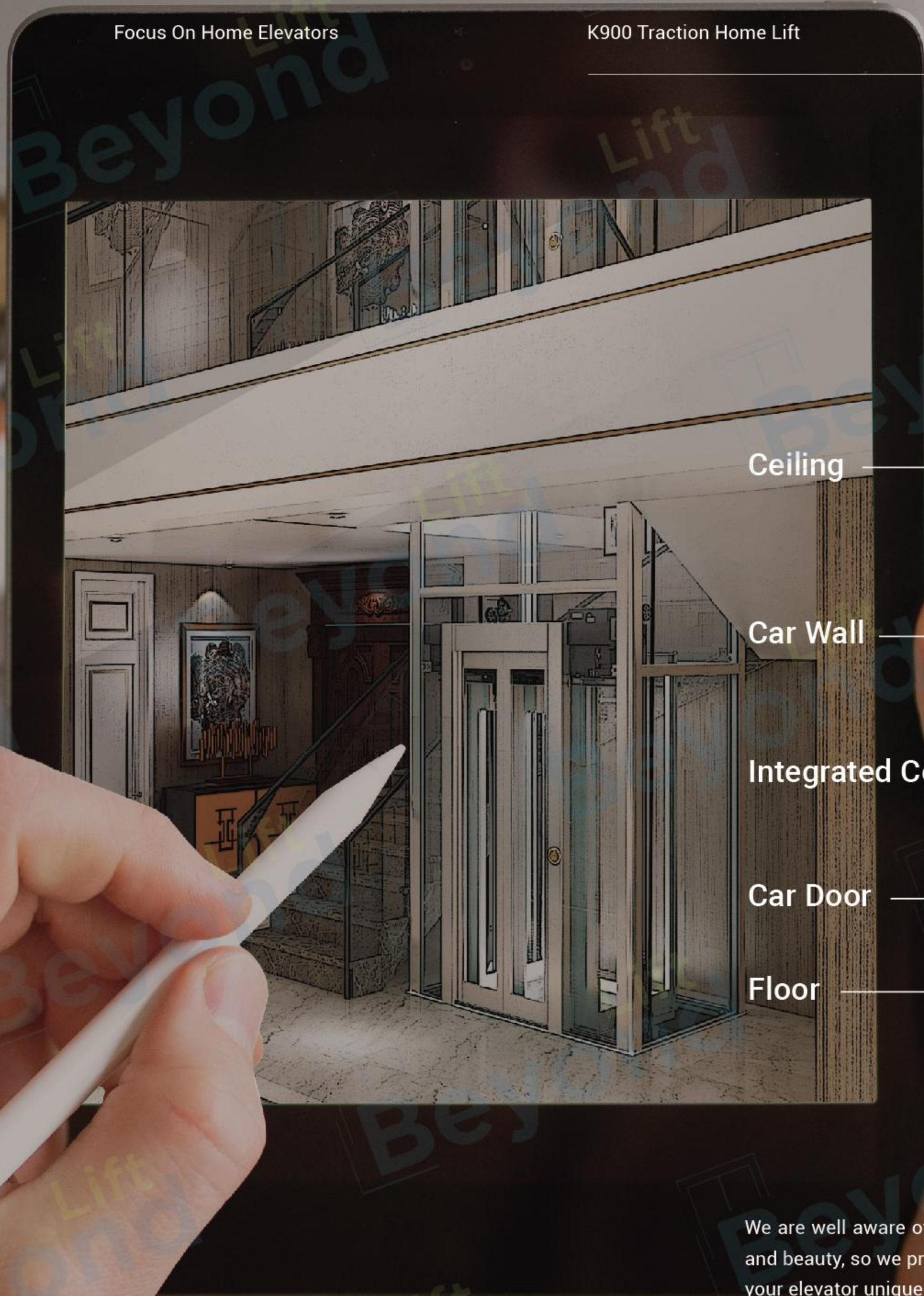

Ceiling

Car Wall

Integrated Control Box

Car Door

Floor



We not only focus on providing high-quality home elevators, but also provide customized decoration services.

We are well aware of the importance of car interior decoration in increasing comfort and beauty, so we provide each customer with personalized design solutions to make your elevator unique and show your personality and taste.

Multiple Security Mechanisms



We are committed to providing our customers with safe and reliable elevators. We insist on selecting high-quality accessories and materials, we ensure that each elevator will be under testing and quality control to meet your needs and expectations.



Door Machine

It adopts permanent magnet synchronous motor, fully closed-loop servo control technology, high efficiency, energy saving and environmental protection. It adopts integrated car door lock knife (OMS106) to truly realize the synchronous opening and closing of the hall car door.



Light Curtain Protection

Light curtain protection can promptly detect objects entering the elevator door area to avoid pinch accidents, protect passenger safety, and improve comfort and convenience.



Gearless Traction Machine

Energy-saving

Low heat loss, operating costs and minimum working efficiency up to 95%. Traditional savings of 40% compared with conventional technology.

Smooth running

High precision manufacturing, running smoothly and comfortable. Combined with precise speed control and fully controlled closed loop VVVF drive system, it can make the stop and level very smooth and accurate.

Stable and durable

We adopt strict design standards and we use a minimum number of moving parts to ensure the elevator stability and continuity.

Environmental protection

Because the gearless tractor does not need complex lubrication system, it completely solves the problem of environmental pollution caused by the oil leakage of the traditional tractor and meets the requirements of maintenance free and environmental protection of the motor.

Magnetic Leveling Device

Electromagnetic Safety Gear

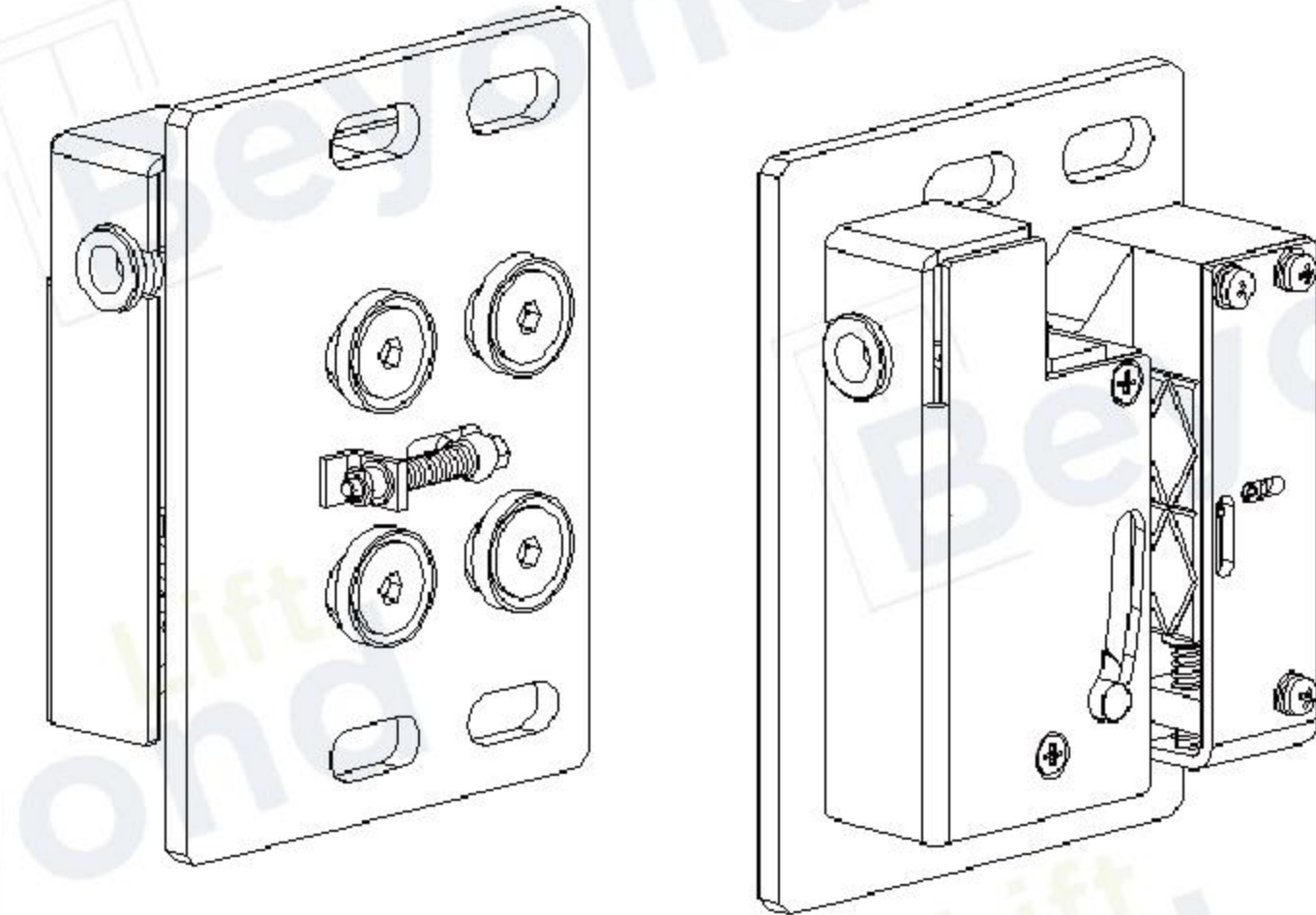

Electromagnetic safety gear is an elevator safety device based on the principle of electromagnets. Compared with hydraulic safety gear and mechanical safety gear, smoother braking effect, faster reaction speed.

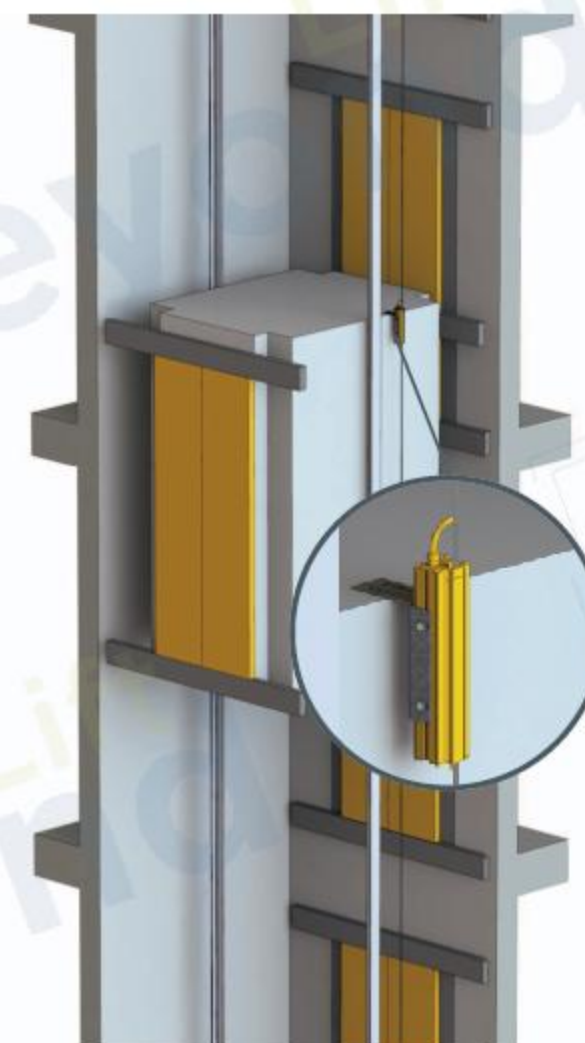

German ELGO magnetic scale-absolute position shaft measurement system LIMAX2M is equivalent to a combination of speed limiter + photoelectric switch + end station switch, with a control accuracy of 0.1mm.

It requires very little installation space, and dust, dirt and even black smoke will not affect the effect.

Even under humid and high temperature conditions, the system can operate stably and has the advantages of long service life and maintenance-free.

STANDARD CONFIGURATION



Standard Car Ceiling



Standard Color
(Cabin frame and shaft color)



● Standard glass color





Standard Automatic Sliding Door

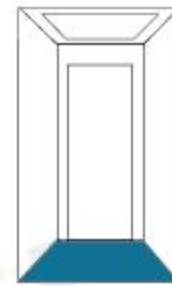

Standard Car Floor (PVC)

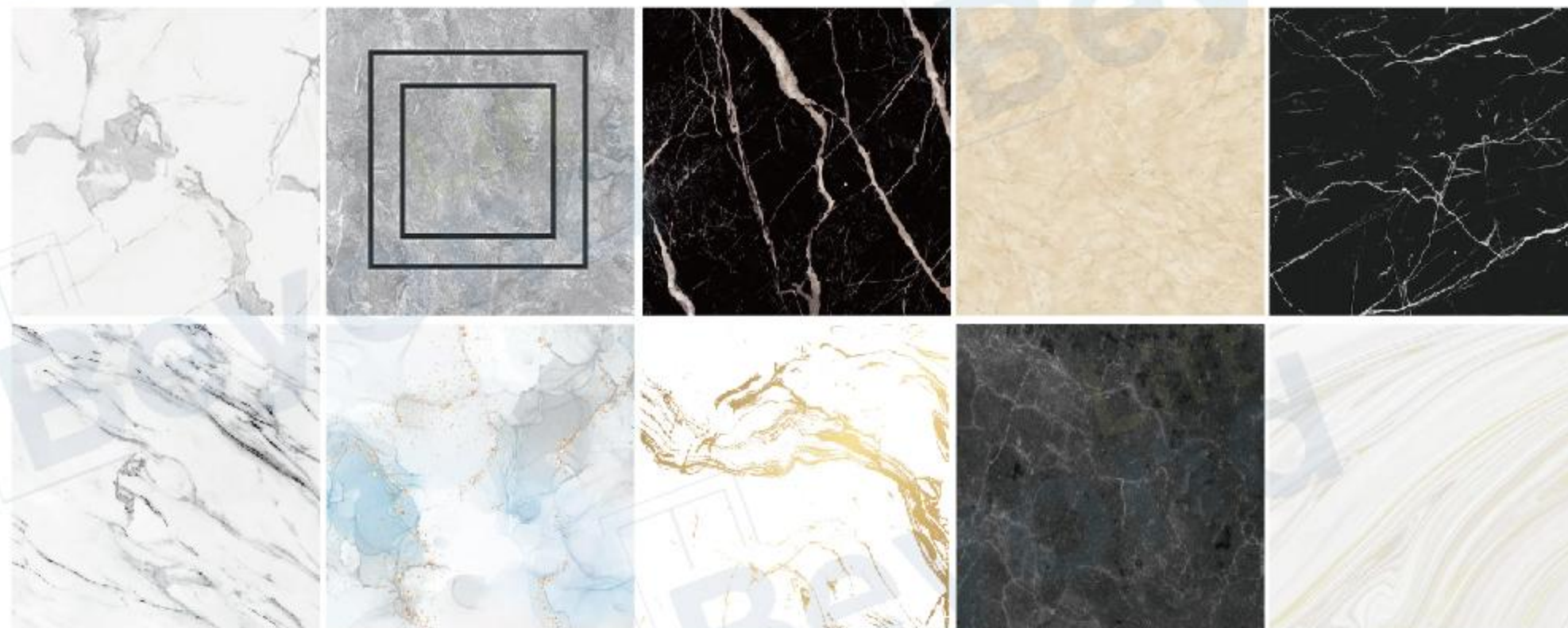

Standard Control Cabinet



BUILT IN ARD



INTELLIGENT RELEASE POWER SUPPLY



SAVING MORE SPACE



CONTACTORLESS CONTROL



LOWER NOISE

OPTIONAL CONFIGURATION



FOCUS ON HOME ELEVATORS

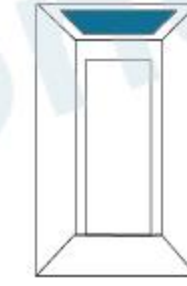

Optional Car Ceiling

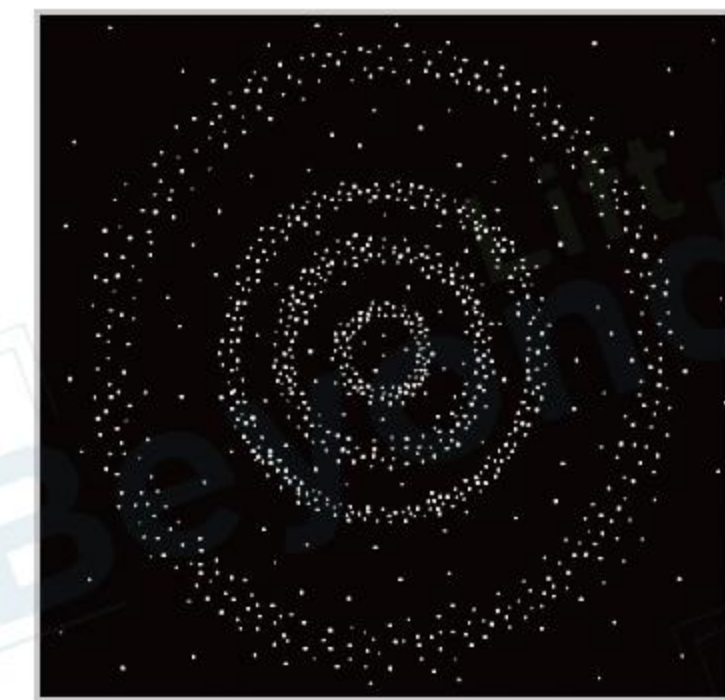
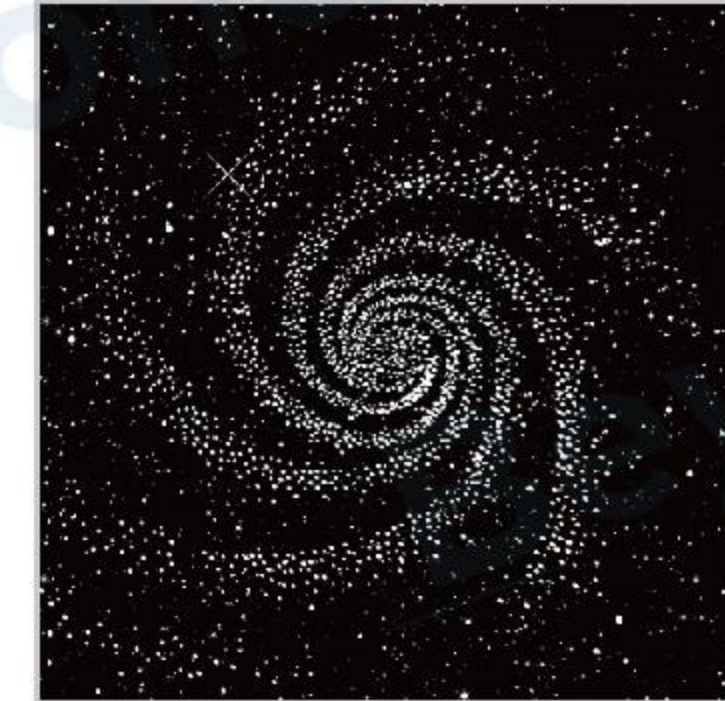

● Optional glass color

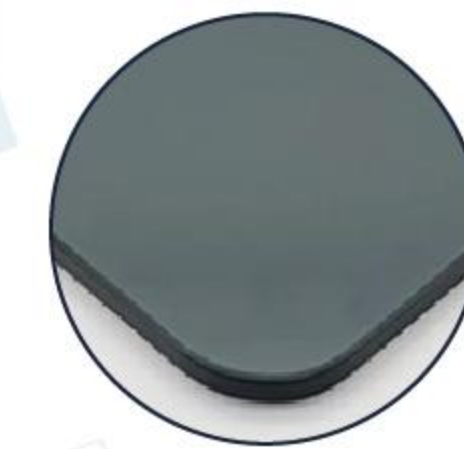
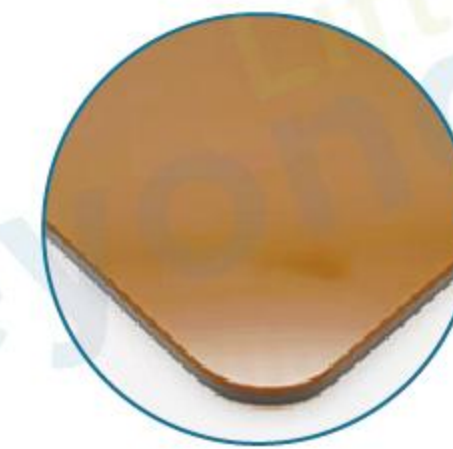



Minimal



Wood Grain



13.3 inches



15.6 inches



Optional Swing Door

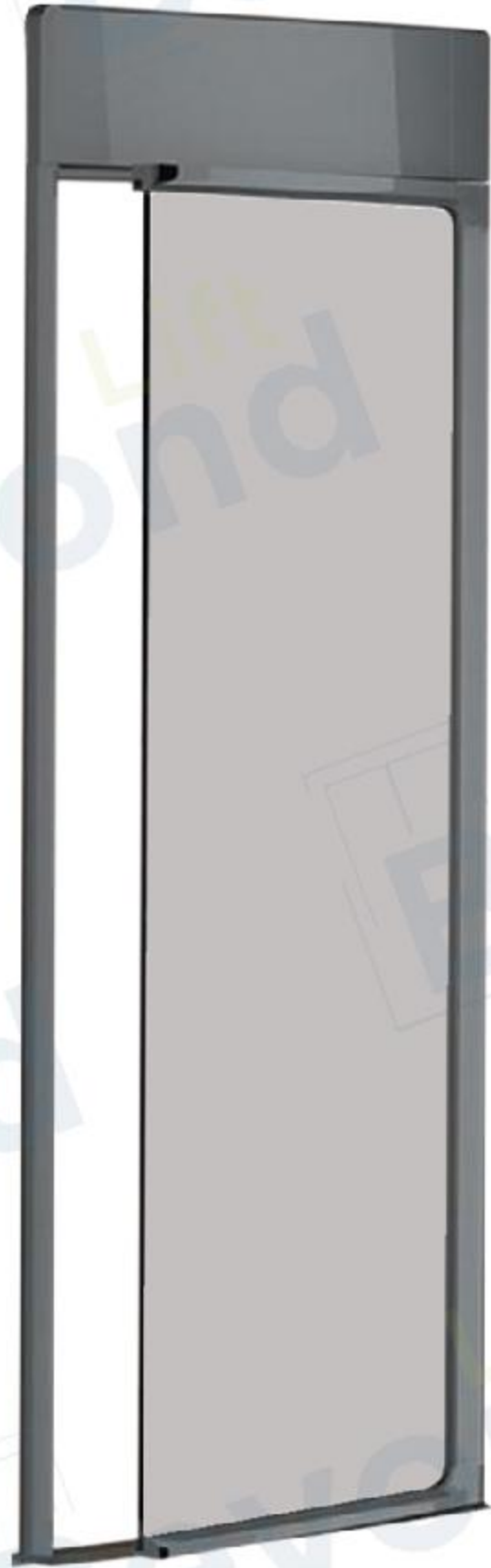

Automatic Single Swing Door

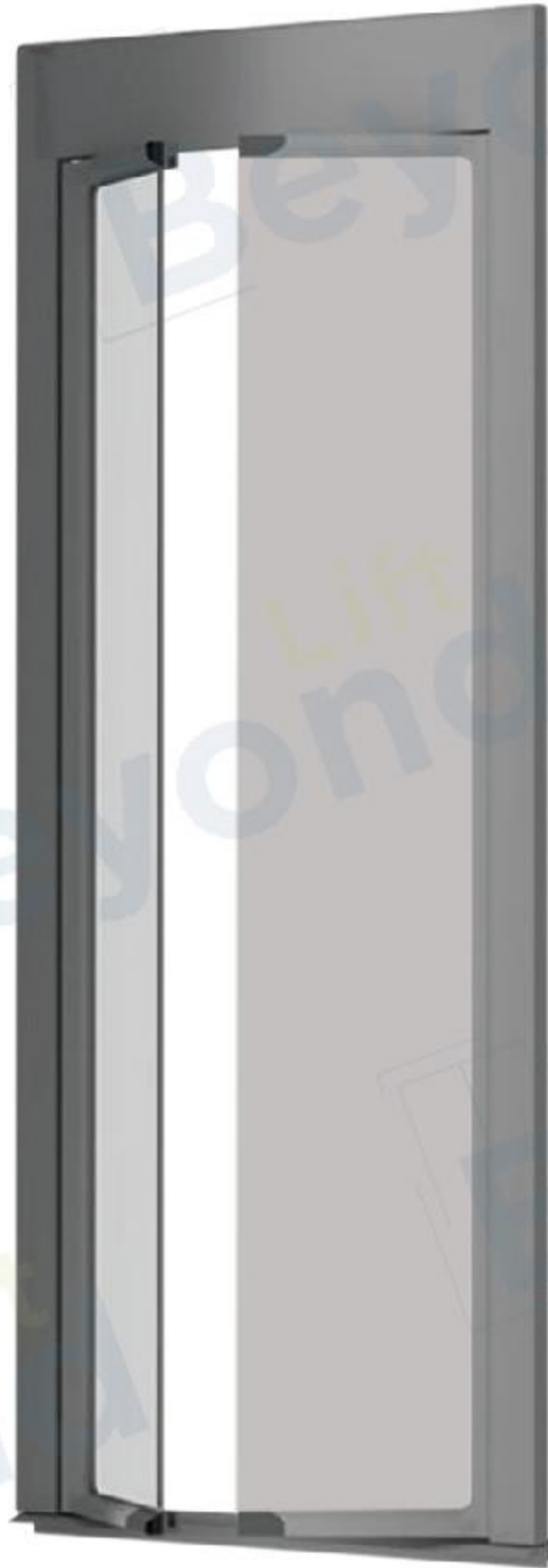

Automatic Double Swing Door



Manual Landing Door

Glass Shaft

Overhead $\geq 2800\text{mm}$ Car clear height 2100mm

